

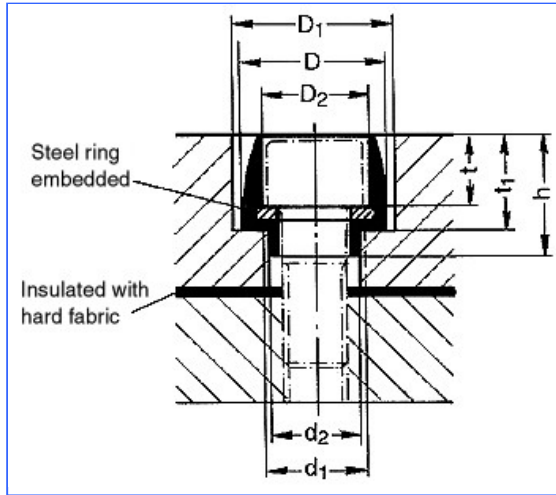

Insulating bushes



For cheese head screws:	Ø D	Ø D1	Ø D2	Ø d1	Ø d2	Screw head depth t	Bush head depth t1	Bush height h	Order number
M4	12.8	14.0	8.0	8.5	7.3	4.5	7.8	12.8	XE0.B04.000
M5	13.8	15.0	9.5	9.5	8.3	5.5	9.3	14.3	XE0.B05.000
M6 VW	15.0	17.2	10.9	10.5	9.5	6.5	12.0	17.0	XE0.B06.000-01
M6	20.0	21.5	10.9	10.5	9.5	6.5	12.0	17.0	XE0.B06.000
M8	22.0	24.6	15.0	13.0	11.6	9.3	14.0	19.0	XE0.B08.000
M10	24.2	27.6	17.0	15.0	14.2	10.5	16.0	21.0	XE0.B10.000
M12	26.3	30.6	18.9	17.0	16.2	12.8	18.3	23.2	XE0.B12.000

Examples:

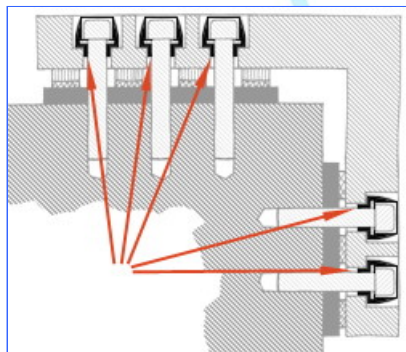
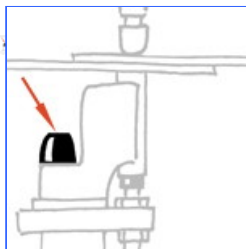



Special Insulating bushes

for Cylinder screws with hexagon socket

for tight building dimensions

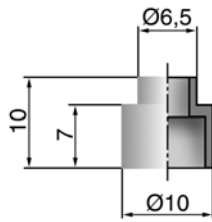

for M4
XE0.B04.000-01

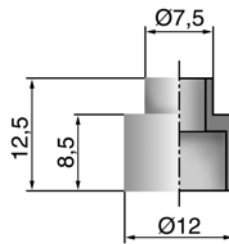

for M5
XE0.B05.000-01

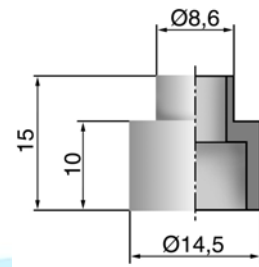

for M6
XE0.B06.000-002

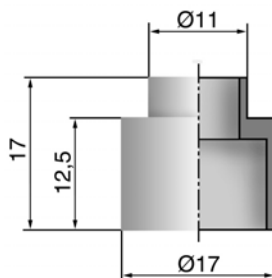

for M8
XE0.B08.000-01

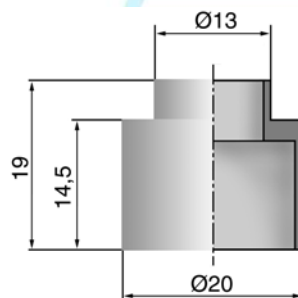

for M10
XE0.B10.000-01

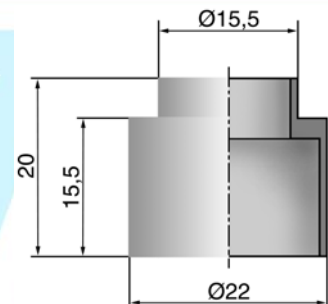

for M12
XE0.B12.000-01

- Area of application
Special Insulating bushes for insulation from cylinder screws in the secondary circuit of resistance welding equipments .

Dimensions, name
Please, choose not indicated details adequately
- Material
HGW 2372.4/S23 up to 230° C heat resistant
- Use
Special insulating bushes due to this standard may only be loaded by the clamp bolt torque. Additionally forces should be absorbed by other adequate measures. Please, also take care of a sufficient support of the special insulating bushes.



Insulating caps

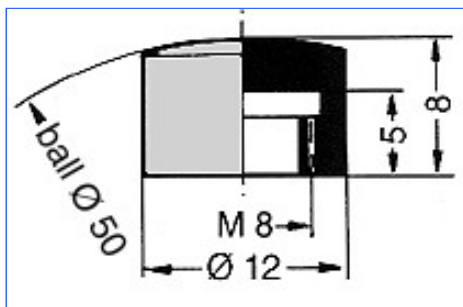
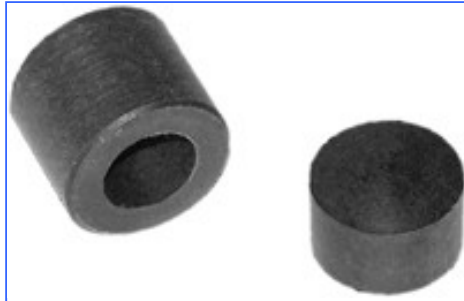

Insulating cap M8 DIN 44 765

For screwing with thread

Area of application: This standard applies to insulating caps for the insulation of screws with thread M8 in the secondary circuit of resistance welding instruments.

Order-number: XE0.K01.080-000

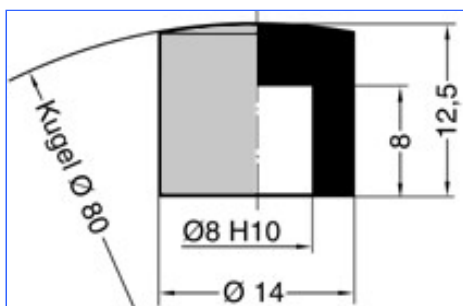

Insulating cap shape C

For insertion

Material: Polyamide, glas fibre strengthened
Surface: Surface line 2 DIN 3141

Order-number: XE0.K02.080-000

Example:

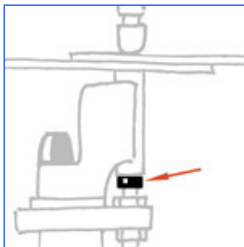



Insulating sheets

Material:
Hgw 2372.1

Examples:

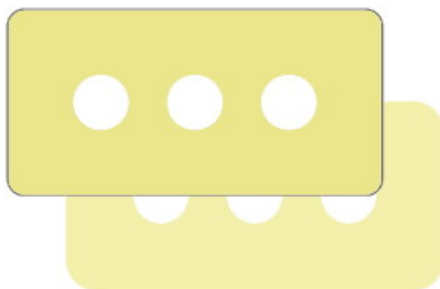
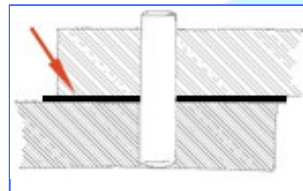
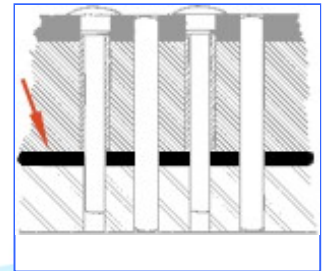
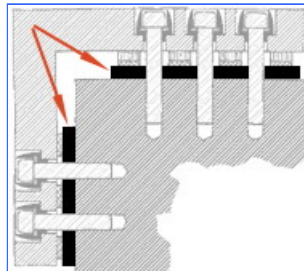

60 x 30 x 2 (3 drillings 9 mm)

Order number: XE0.P020.060003

Available with corner radius 3 or 5

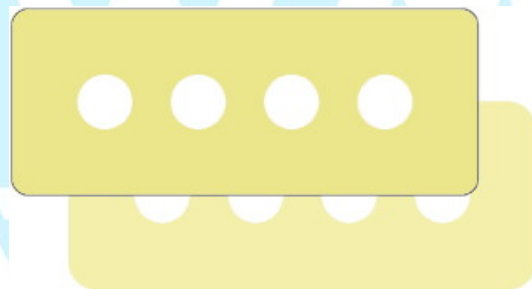

75 x 30 x 2 (4 drillings 9 mm)

Order-number: XE0.P020.060004

available with corner radius 3 or 5



Insulating and protection pieces

Version: 2011-01

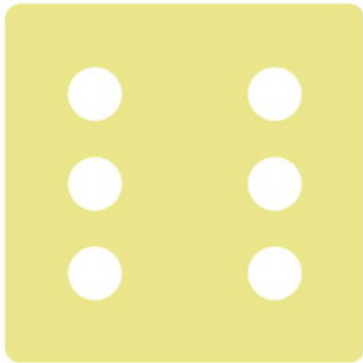

60 x 60 x 2 (6 drillings 9 mm)

Order-number: XE0.P020.060006

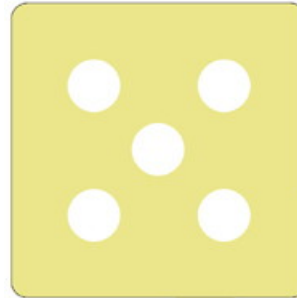

50 x 50 x 2 (5 drillings 9 mm)

Order-number: XE0.P020.050005



60 x 60 x 2 (5 drillings 11 mm)

Order-number: XE0.P020.060005



Insulating and protection pieces

Version: 2011-01

Insulation pins and pipes

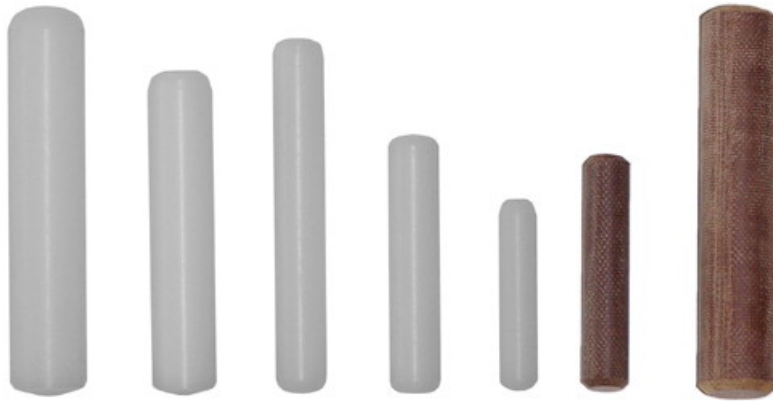

Examples:

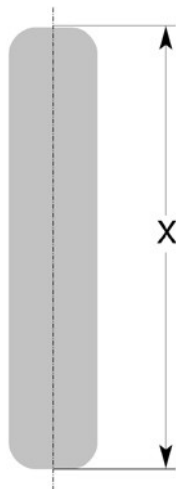
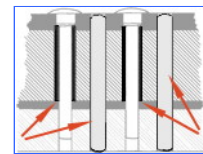
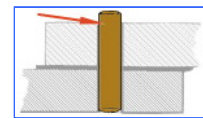

Hard tissue

Ø	X	Order-number
6	30	XE0.S06.300.H00
10	50	XE0.S10.300.H00

Plastic

Ø	X	Order-number
6	30	XE0.S06.300.K00
	40	XE0.S06.400.K00
	50	XE0.S06.400.K00
	60	XE0.S06.600.K00
8	20	XE0.S08.200.K00
	28	XE0.S08.280.K00
	30	XE0.S08.300.K00
	32	XE0.S08.320.K00
	40	XE0.S08.400.K00
	55	XE0.S08.550.K00
10	50	XE0.S10.500.K00
12	60	XE0.S12.600.K00

Other dimensions on demand!

We reserve the right to make changes which are in the interest of technical progress.

© by WMA Schmidt & Bittner GmbH, Baumwaide 23, D-74360 Illfeld-Auenstein, Tel. +49 7062 9066-0, Fax +49 7062 9066-20

info@wma-sb.de or wma-sb@t-online.de, <http://www.wma-sb.de>

Insulating and protection pieces-6



Insulating and protection pieces

Version: 2011-01



Material: Hgw 2375.4 (X) or Hgw 2085 (Y)

Außen-Ø	Innen-Ø	Order-number
7,9	5,9	XE0.H07.059000
8	5,5	XE0.H08.055000
8	5,9	XE0.H08.059000
8	6,0	XE0.H08.060000
8	6,3	XE0.H08.063000
9	7,0	XE0.H09.070000
10	7,9	XE0.H10.079000
10	8,0	XE0.H10.080000
10	8,3	XE0.H10.083000
10	8,5	XE0.H10.085000
12	7,9	XE0.H12.079000
12	9,5	XE0.H12.095000
12	10,0	XE0.H12.100000
14	12,0	XE0.H14.120000
16	14,0	XE0.H16.140000
25	19,0	XE0.H25.190000
25	22,0	XE0.H25.220000

The last three positions of the order-number are reserved for your individual length.

(Example: 50.0 cm = 500 mm = 500 - XE0.H25.220**500**).

Write the designation from the material (X or Y) at the end of the order-number.

All lengths are available up to 1 m!



Insulating and protection pieces

Version: 2011-01

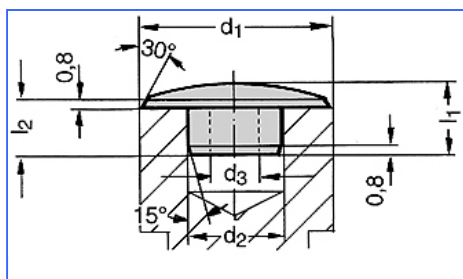

Protective caps for cheese head screws with inner hexagon

Material: Plastic, hardness 90 Shore.
Surface: smooth, color grey (RAL 7031)

Nominal Size sw	for DIN 912	d1	d2-0,1	d3	l1	l2	Order-number
3	M 4	7	3	--	2.4	1.2	XE0.A04.000
4	M 5	9	4	--	2.8	1.5	XE0.A05.000
5	M 6	10	5	2.5	3.3	1.8	XE0.A06.000
6	M 8	13	6	3.0	4.1	2.3	XE0.A08.000
8	M 10	16	8	4.0	4.9	2.9	XE0.A10.000
10	M 12	18	10	5.5	5.7	3.5	XE0.A12.000

Example:

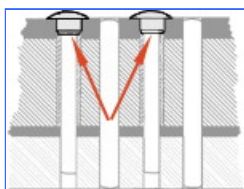

We reserve the right to make changes which are in the interest of technical progress.

© by WMA Schmidt & Bittner GmbH, Baumwaide 23, D-74360 Illfeld-Auenstein, Tel. +49 7062 9066-0, Fax +49 7062 9066-20
info@wma-sb.de or wma-sb@t-online.de, <http://www.wma-sb.de>